

目 录

一、运输作业组织与管理模块	2
.....	2
.....	5
.....	7
.....	10
.....	13
.....	16
.....	19
.....	22
.....	24
.....	30
二、仓储与配送作业组织与管理模块	34
.....	34
.....	40
.....	46
.....	52
.....	58
.....	63
.....	70
.....	76
.....	82
.....	88
.....	94
.....	98
.....	103
.....	108
.....	113
.....	118
.....	125
.....	131
.....	137
.....	143
三、国际物流作业组织与管理模块	150
.....	150
.....	152
.....	155
.....	158
.....	161
.....	164
.....	166
.....	168
.....	172

.....	175
.....	177
.....	179
.....	181
.....	184
.....	188
.....	190
.....	193
.....	195
.....	197
.....	199
.....	202
.....	204
.....	207
.....	208
.....	210
四、 快递物流作业组织与管理模块.....	213
.....	213
.....	216
.....	219
.....	224
.....	228
.....	231
.....	234
.....	238
.....	242
.....	246
.....	249
.....	252
.....	255
.....	258
.....	261
.....	264
.....	267
.....	271
.....	274
.....	277
.....	280
.....	283
.....	287
.....	290
.....	293

湖南商务职业技术学院物流管理专业学生技能考核题库

一、运输作业组织与管理模块

○

○

○

--	--	--

○

10000

4

6000

15

○

--	--	--	--	--

() 任务描述

○

:

○

○

4

10

5000

300000

15

○

20

/								
/								
			kg	m ³				
□ □				□ □				
□ □								
						□ □ □ □		
	3							

○

15

() 任务描述:

1‰

-
-
-

20

15





17.5

17.5

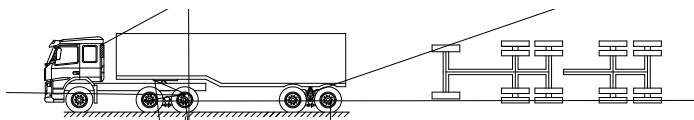

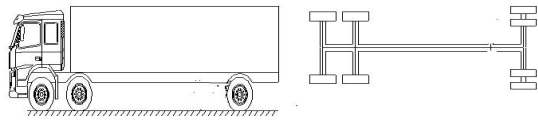

9.6

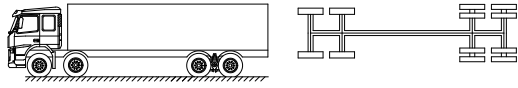

9.6

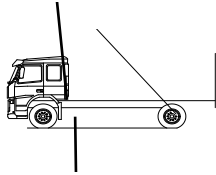

() 任务描述:



○

○

○

○

○

() 任务描述

○

15

○

D

1.65 /

347 /

4‰

10

25 /

12

250 /

20

○

20

D

/									
/									
*	*	*	* kg	* m ³	*	*	*	*	
<input type="checkbox"/> <input type="checkbox"/>			<input type="checkbox"/> <input type="checkbox"/>						
<input type="checkbox"/> <input type="checkbox"/>									
*						<input type="checkbox"/> <input type="checkbox"/> <input type="checkbox"/> <input type="checkbox"/>			
	3								

○

D

15

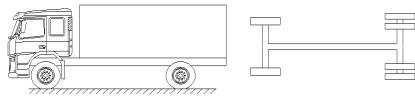
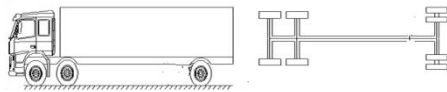
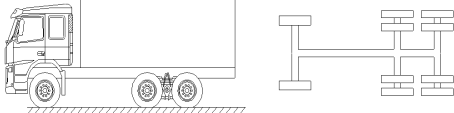
	1	4X2	
			
			

○

10

2

3

60

4

2

100

20%

80%

1

() 任务描述

1 4X2

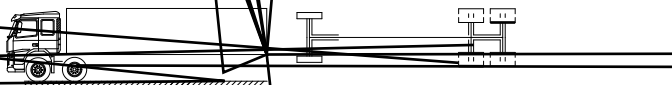
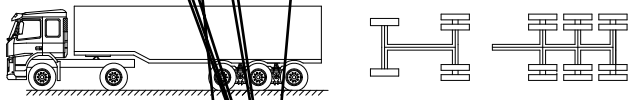
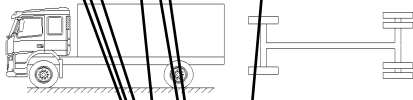



() 任务描述

-
-
-
-
-

() 任务描述

() ()

Marks & Nos.	Descriptions	NO.of Packages ()	Measurement ()	Gross Weight KGS	Net Weight KGS	Total Price USD
AL DAH	CLEANING BALL	3500	53CMX21CMX15CM 0.0167M3/	12kg/	11kg/	1000

()
()
()
()
()

THC TERMINAL HANDLING CHARGE	USD100/20GP USD150/40GP USD150/40HQ	
ORC ORIGIN RECEIPT CHARGE	USD190/20GP USD310/40GP USD310/40HQ	THC
BAF Bunker Adjustment Factor	USD394/20GP USD 788/40GP USD 788/40HQ	
AMS America manifest system	USD25/	
DHF Document handling fee	USD50/	
SLF SEAL FEE,	USD50/20GP USD 30/40GP USD 30/40HQ	
PSS:Peak Season Sucharges	USD30/20GP USD 30/40GP USD 30/40HQ	



()			

Sailing Schedule from : Shenzhen,Shenzhen,Guangdong,China	
To : Los Angeles,Los Angeles,CA,United States	
Origin City : Shenzhen,Shenzhen,Guangdong,China	CY/DOOR
Destination City : Los Angeles,Los Angeles,CA,United States	CY/DOOR

序号号	航线	船名	航次	截关时间	装货港	预计离港时间	实际离港时间	卸货港
1	YPSW	YM UNISON	59E	2016-04-22 17:00	Yantian	2016-04-25		Los Angeles
2	SEA	NORTHERN JAVELIN	002E	2016-04-23 12:00	Yantian	2016-04-27		Long Beach
3	AAS2	CMA CGM LIBRA	095TXE	2016-04-25 16:00	Yantian	2016-04-28		Long Beach
4	YPSW	YM UBIQUITY	22E	2016-04-29 17:00	Yantian	2016-05-02		Los Angeles
5	SEA	C SCL PUSAN	117E	2016-04-30 12:00	Yantian	2016-05-04		Long Beach
6	AAS2	CMA CGM COLUMBA	097TXE	2016-05-02 16:00	Yantian	2016-05-05		Long Beach
7	SEA	COSCO NINGBO	069W	2016-05-06 11:00	Yantian	2016-05-08		Long Beach
8	YPSW	YM UBERTY	50E	2016-05-06 17:00	Yantian	2016-05-09		Los Angeles
9	SEA	COSCO EXCELLENCE	027E	2016-05-07 12:00	Yantian	2016-05-11		Long Beach
10	AAS2	CMA CGM CENTAURUS	099TXE	2016-05-09 16:00	Yantian	2016-05-12		Long Beach
11	YPSW	YM MASCULINITY	32E	2016-05-13 17:00	Yantian	2016-05-16		Los Angeles
12	SEA	HONG KONG BRIDGE	039E	2016-05-14 12:00	Yantian	2016-05-18		Long Beach
13	AAS2	CMA CGM THALASSA	101TXE	2016-05-16 16:00	Yantian	2016-05-19		Long Beach



COSCO CONTAINER LINES

干货箱



	箱体内部尺寸			箱体内容积及载重量		箱门开度尺寸	
	L	W	H	Cu	P	W	H
20'	5898	2352	2393	33.2	21740/28230#	2340	2280
40'	12032	2352	2393	67.7	26630	2340	2280
HC	12032	2352	2698	76.3	26520	2340	2585

冷藏箱



	箱体内部尺寸			箱体内容积及载重量	
	L	W	H	Cu	P
20'	5444	2284	2267	28.5	21135/27160#
40'	11583	2284	2250	58.7	26580
HC	11583	2284	2659	67.9	26380

开顶箱

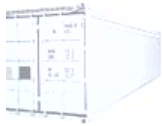

	箱体内部尺寸			箱体内容积及载重量	
	L	W	H	Cu	P
20'	5900	2330	2337	32.6	21740
40'	12025	2330	2337	65.8	26410

○

○

() 实施条件

() 考核时量

		15			

() 任务描述

LX
(computer parts)

DO

2014 10 7 20 00
60X50X40CM 10kg/ 16000 /
5

M	-45	+45	+100	+300	+500	+1000
500	32	23	19	18	17	16



*Shipper("The Customer")		Mawb No:	Hawb No.:
*Consignee			
Notify Party Tel: Fax:			
Name of Carrier	*Departure Airport	*Airfreight Charges: <input type="checkbox"/> Prepaid <input type="checkbox"/> Collect	Other Charges: <input type="checkbox"/> Prepaid <input type="checkbox"/> Collect
*Destination	Country of Origin(Goods):		

*Marks and Kind of Packages :Description of Goods		*Gross Weight	*Measurement	
Specify Currency	Declared Value for Customs	Declared Value for Carriage	Insurance Amount	Shipper's C.O.D
Special Instructions: Agree Rate:		We hereby guarantee payment of all freight collect charges due to the forwarders or to the carrier. If the shipment is abandoned ,refused by consignee. Returned at our request, confiscated by the customs or for any other reason can't be delivered within a reasonable time		
Documents accompanying Airway Bill: <input type="checkbox"/> Packing List <input type="checkbox"/> Certificate of Origin <input type="checkbox"/> Commercial Invoice <input type="checkbox"/> Consular Invoice		Signatory's Name in Block Letters:		
Received the above shipment for: By:		Signature and Stamp: Date: (Month/Day/Year)		

○

○

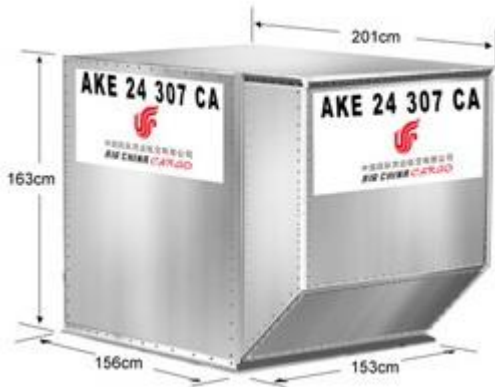

○

○

() 实施条件

() 考核时量

60

() 评分细则

2 100
20% 80%
1
1

(80)		20			
		5		5	10
		15			
		20			10 5
				10	

1 2

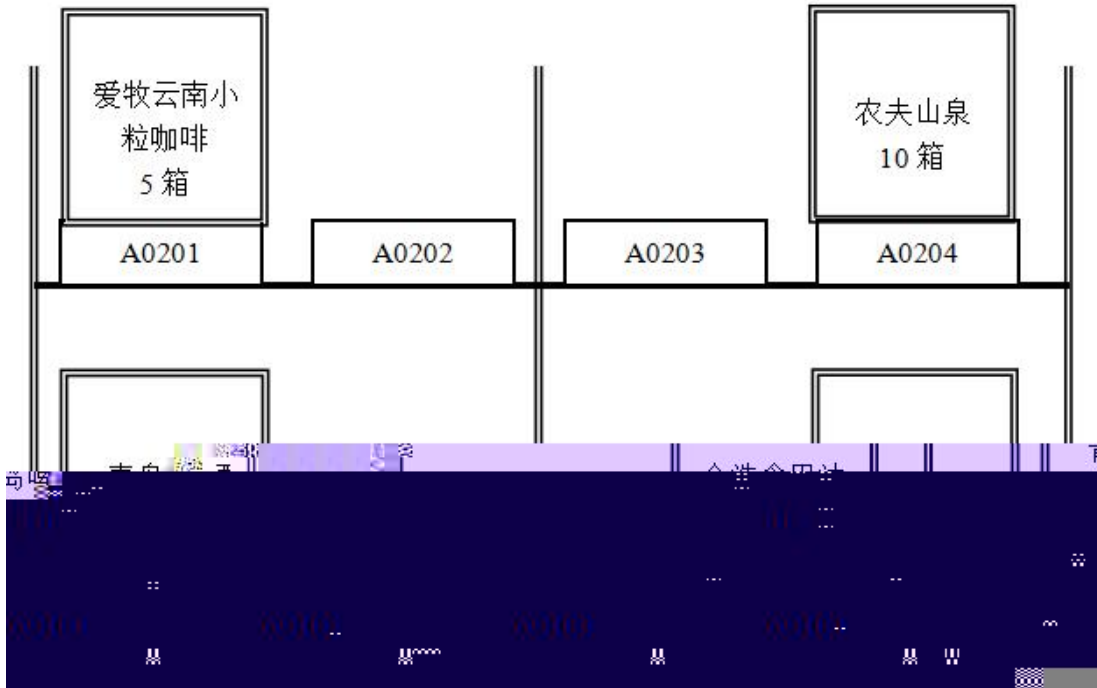

产品运输单

HD1011160001

			50	100ml*5	50		
			40	310ml	40		
3			20	100ml	20		

-
-
-
-
-
-
-
-

	1	
	2	1

	5		2	1
	10		2	0
	5		2	1
80	10	ABC	6	2
	10		ABC	4
	10		10	3
	5		1	
	5		5	
	5		3	
	5		2	
	5		2	3
			1	

	5		1 2 3	
	2	WMS	WMS 2	
	8		2 6 1	
	5		0.5 2 3	
	10		1 0.5 4 6 2 30mm	
	5	RF	RF 1	
	7		1 0.5 4 3 1 150mm	
	3	RF	RF 3	

1 2

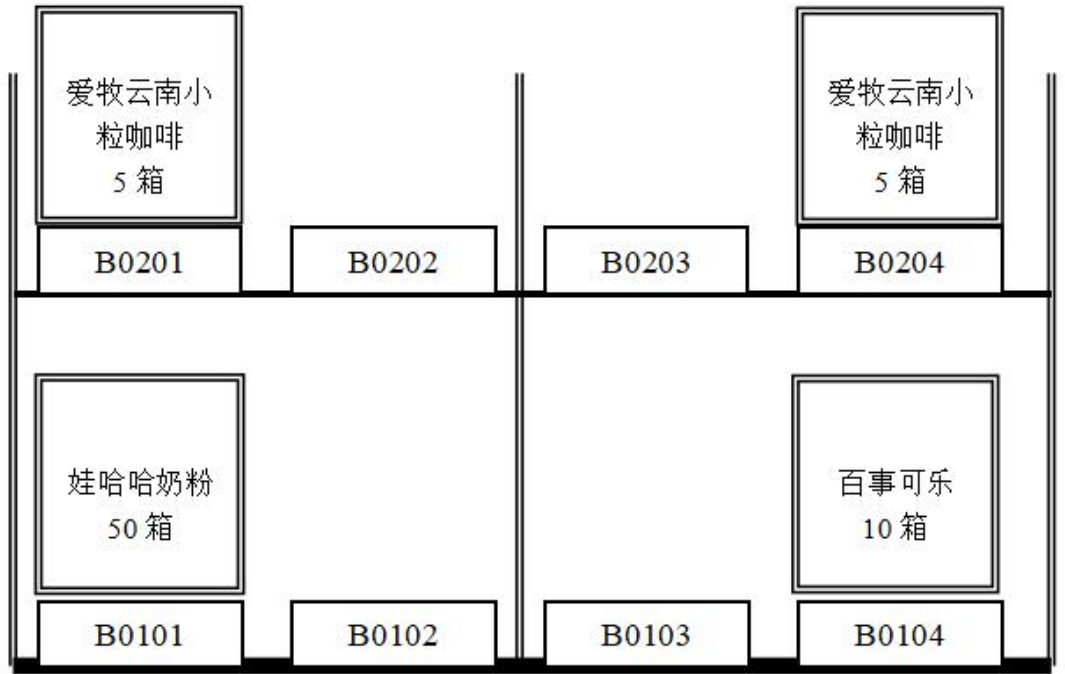
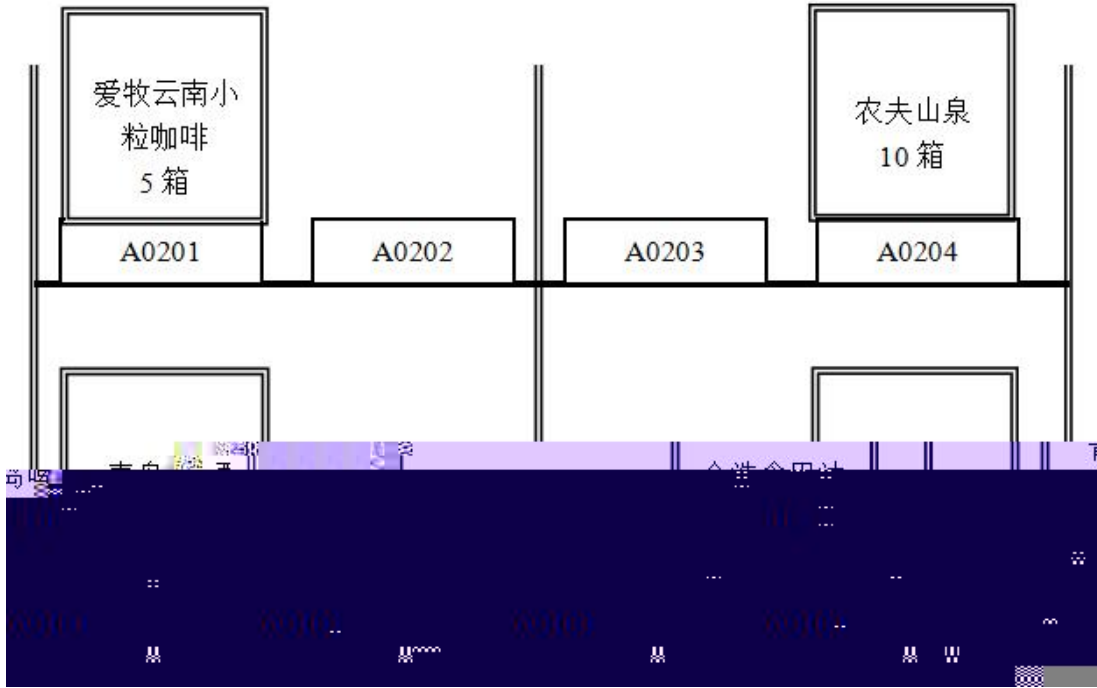

产品运输单

HD1011160001

				310ml	40		
			40		40		
3			20		20		

-
-
-
-
-
-
-
-

	1	

	2	1

	5			2	1
				2	
	10			1	
				2	
	10			2	
	5			2	1
				2	
80	10	ABC		6	2
			ABC	4	
	10			10	3
				1	
	5			5	
	5			3	
	5			2	
			2	3	
	5		1		
			2		
			1	3	

		2	WMS	WMS	2	
		8			6	1
					2	
		5			3	
				0.5	2	
		10			6	2
					4	
				1 0.5		30mm
		5	RF		RF	1
		7			3	1
					4	
				1 0.5		150mm
		3	RF		RF	3

2020 1 7

1 2

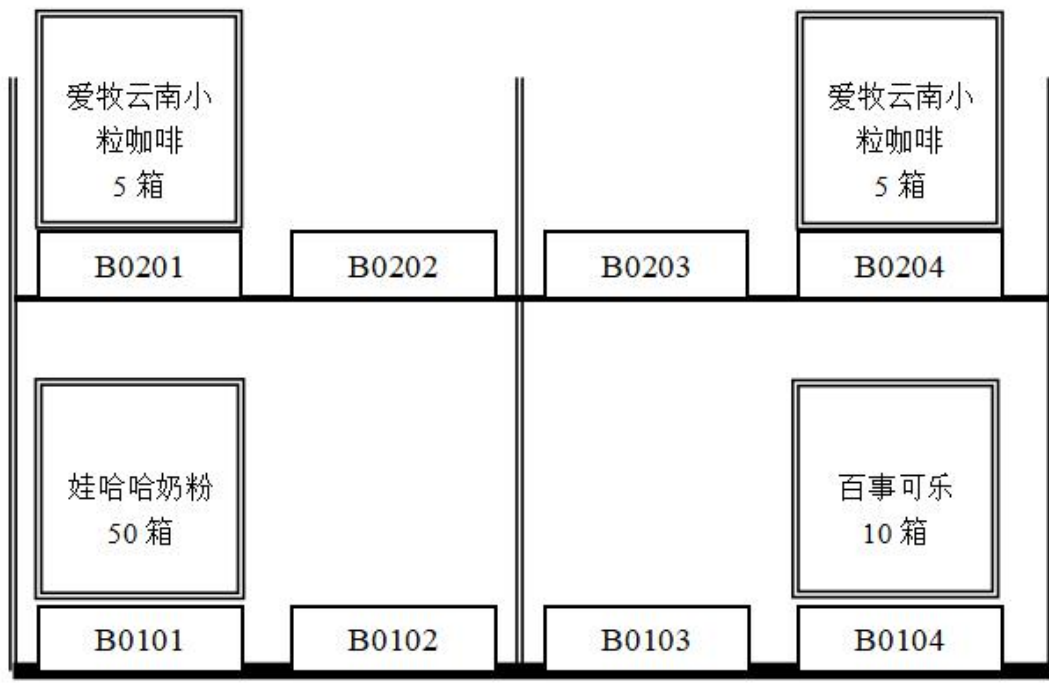
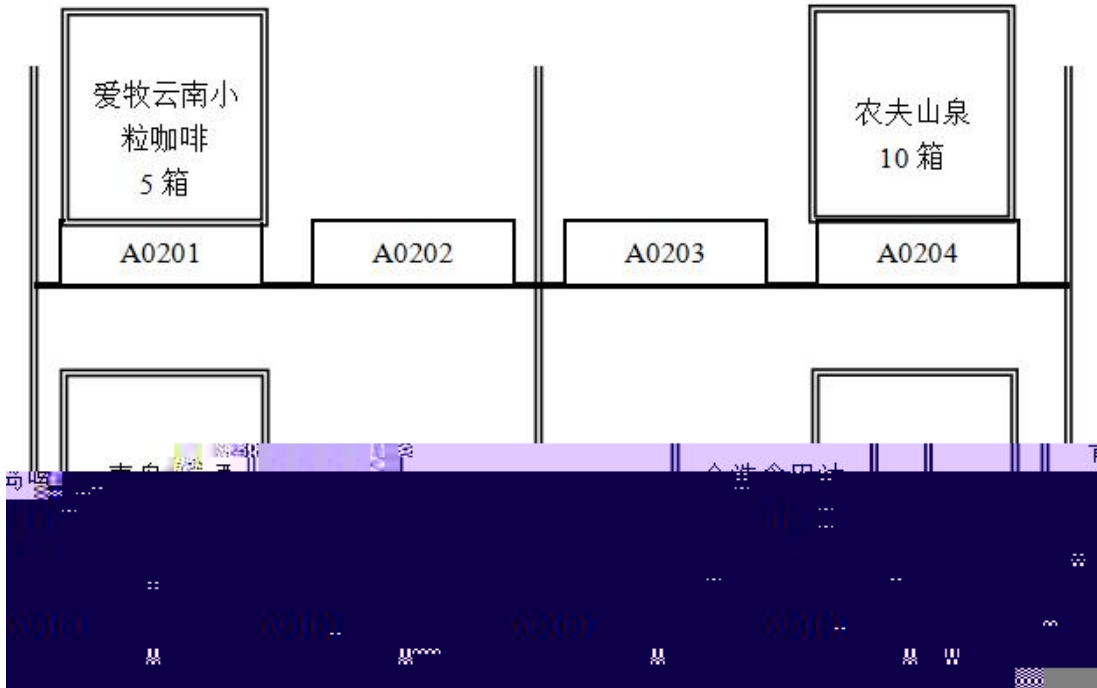

产品运输单

HD1011160001

			20	100ml*5	20		
			40	100ml	40		
			40	330ml	30		

-
-
-
-
-
-
-
-

	2	1

	5		2	1
	10		2	0
	5		2	1
80	10	ABC	6	2
	10		ABC	4
	10		10	3
	5		1	
	5		5	
	5		3	
	5		2	3
5		1	2	
	5		1	3

		2	WMS	WMS	2	
		8			6	1
					2	
		5			3	
				0.5	2	
		10			6	2
					4	
				1	0.5	
						30mm
		5	RF		RF	1
		7			3	1
					4	
				1	0.5	
						150mm
		3	RF		RF	3

1

2020 2 7

1 2

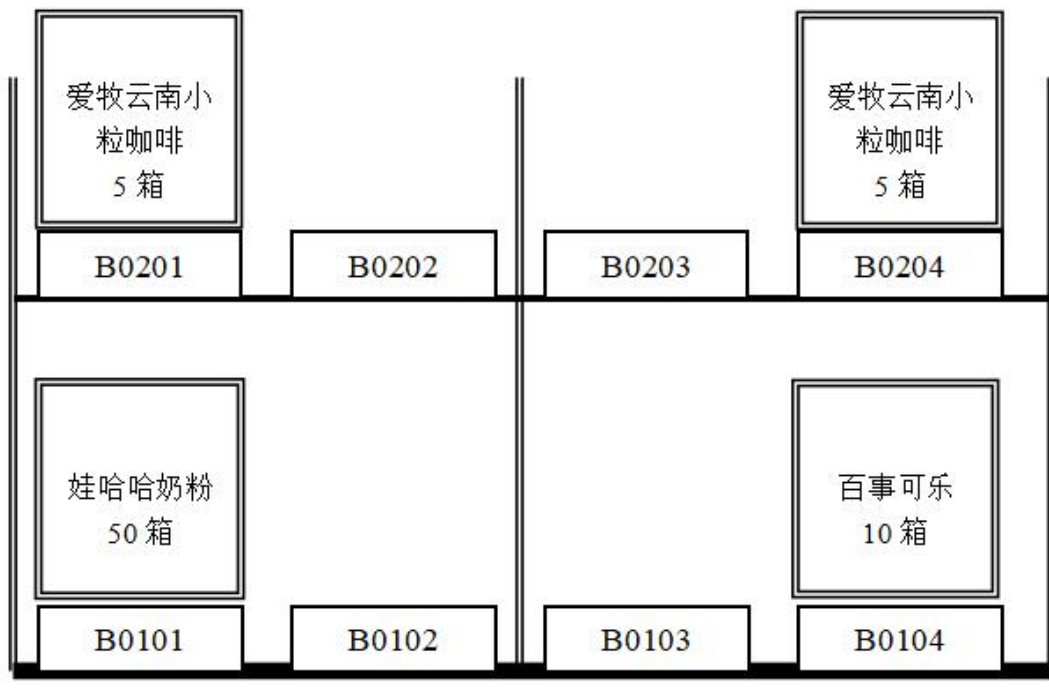
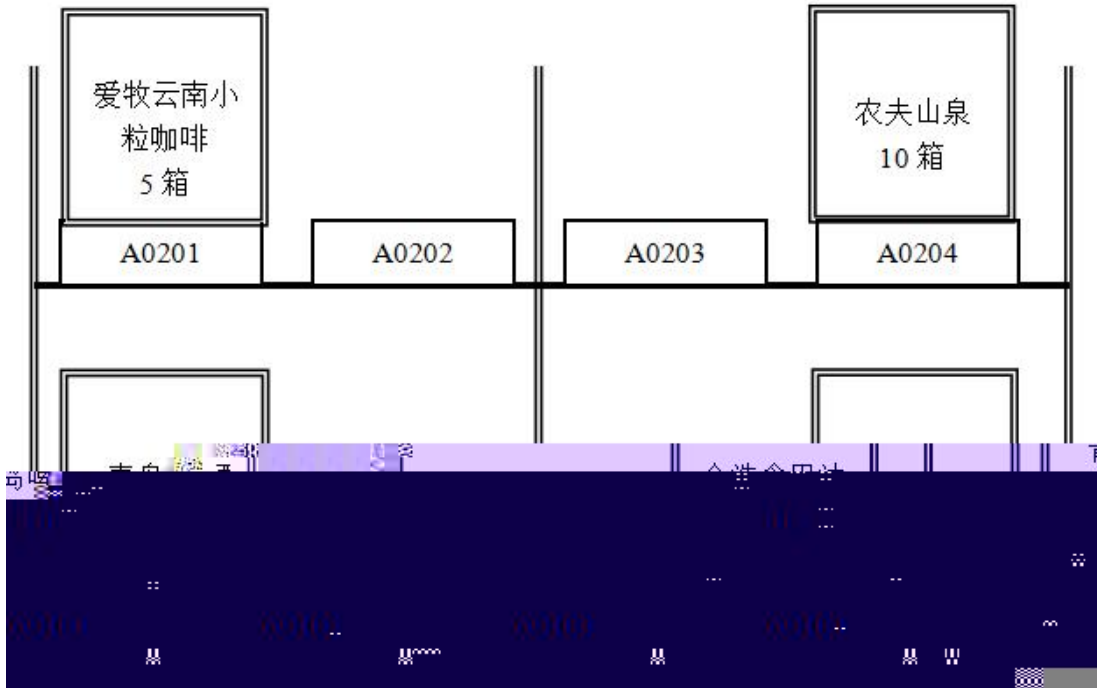

产品运输单

HD1011160001

			40	330ml	40		
			30	100ml*5	30		
			30	310ml	30		

○

○

○

○

○

○

○

○

	1	

	2 1	

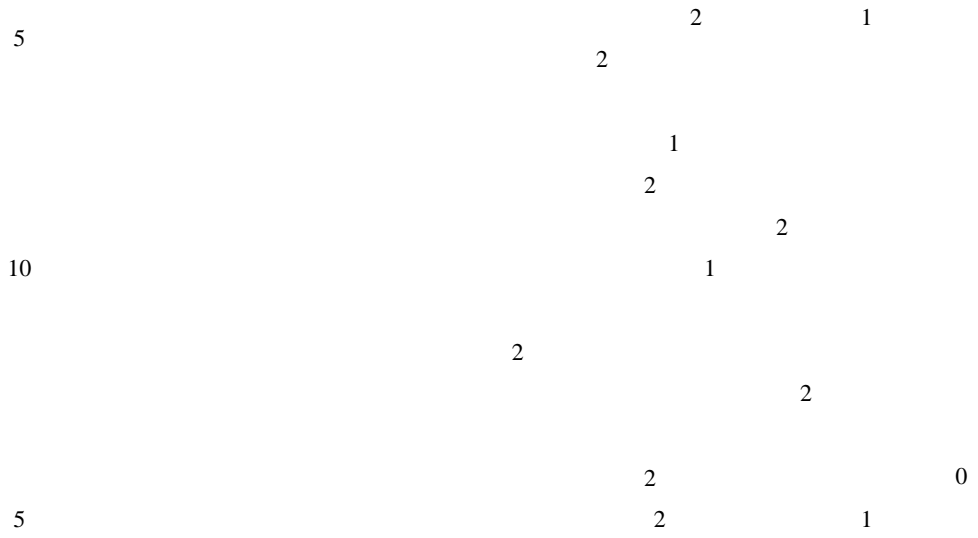

		2	WMS	WMS	2	
		8			6	1
					2	
		5			3	
				0.5	2	
		10			6	2
					4	
				1	0.5	
						30mm
		5	RF		RF	1
		7			3	1
					4	
				1	0.5	
						150mm
		3	RF		RF	3

2020 4 7

1 2

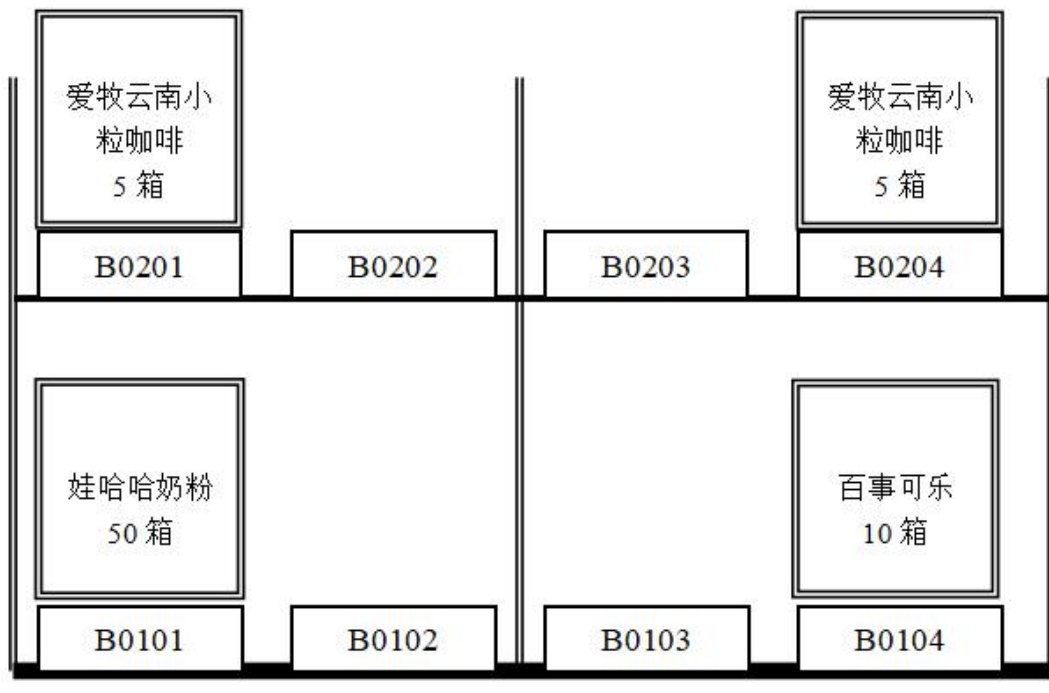
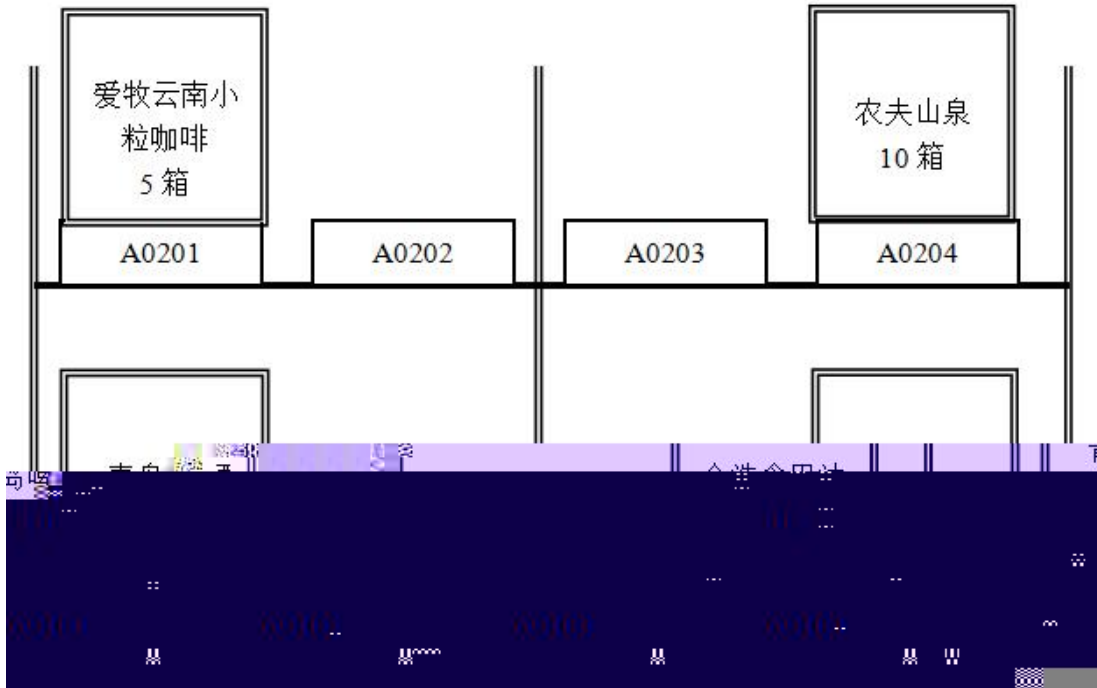

产品运输单

HD1011160001

			40	310ml	40		
			40	330ml	40		
3			20	100ml	20		

4040LÖ•D S \$

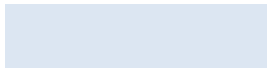

	2	1

	5			2	1	
				2		
	10			1		
				2		
	10			1	2	
				2		
	5			2	1	
				2		
	5			2	1	
80	10	ABC			2	
				6		
			ABC		4	
	10				10	3
					1	
	5				5	
						3
5				2		
				2	3	
5				1		
				2		
				1	3	

		2	WMS	WMS	2	
		8			6	1
					2	
		5			3	
				0.5	2	
		10			6	2
					4	
				1	0.5	
						30mm
		5	RF		RF	1
		7			3	1
					4	
				1	0.5	
						150mm
		3	RF		RF	3

2019 11 7

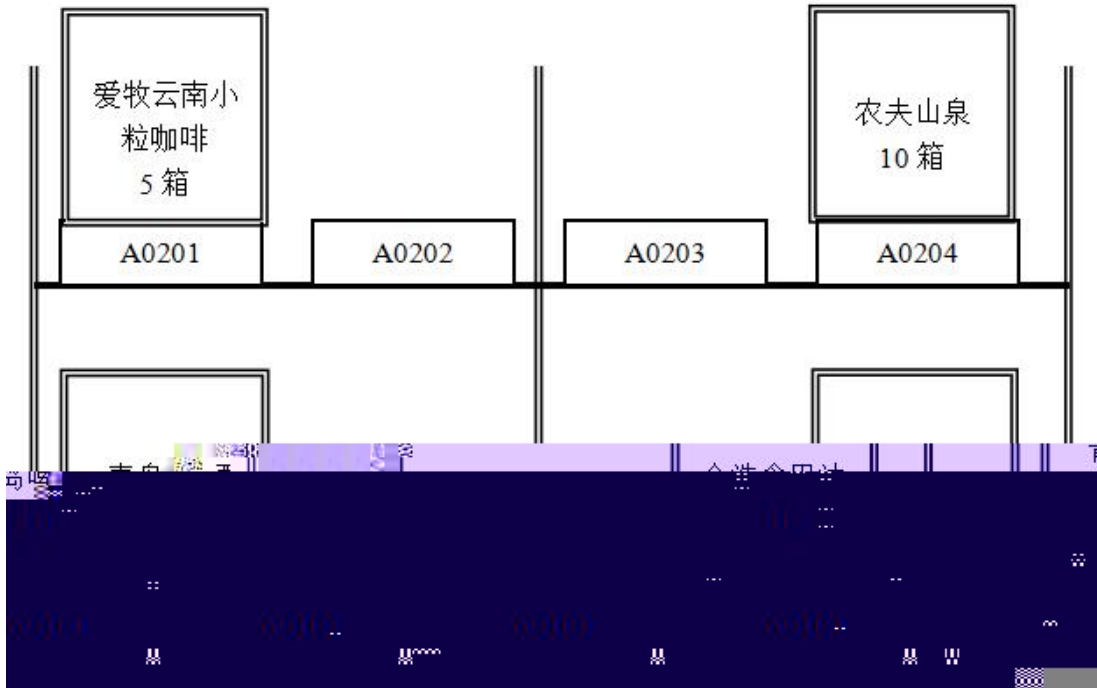

产品运输单

	2	1

	5			2	1
				2	
	10			1	
				2	
	5			2	1
				2	
80	10	ABC		6	2
			ABC	4	
	10			10	3
				1	
	5			5	
	5			3	
	5			2	3
5			1		
	5			2	
			1	3	

		2	WMS	WMS	2	
		8			6	1
					2	
		5			3	
				0.5	2	
		10			6	2
					4	
				1	0.5	
						30mm
		5	RF		RF	1
		7			3	1
					4	
				1	0.5	
						150mm
		3	RF		RF	3

2019 9 7

1 2

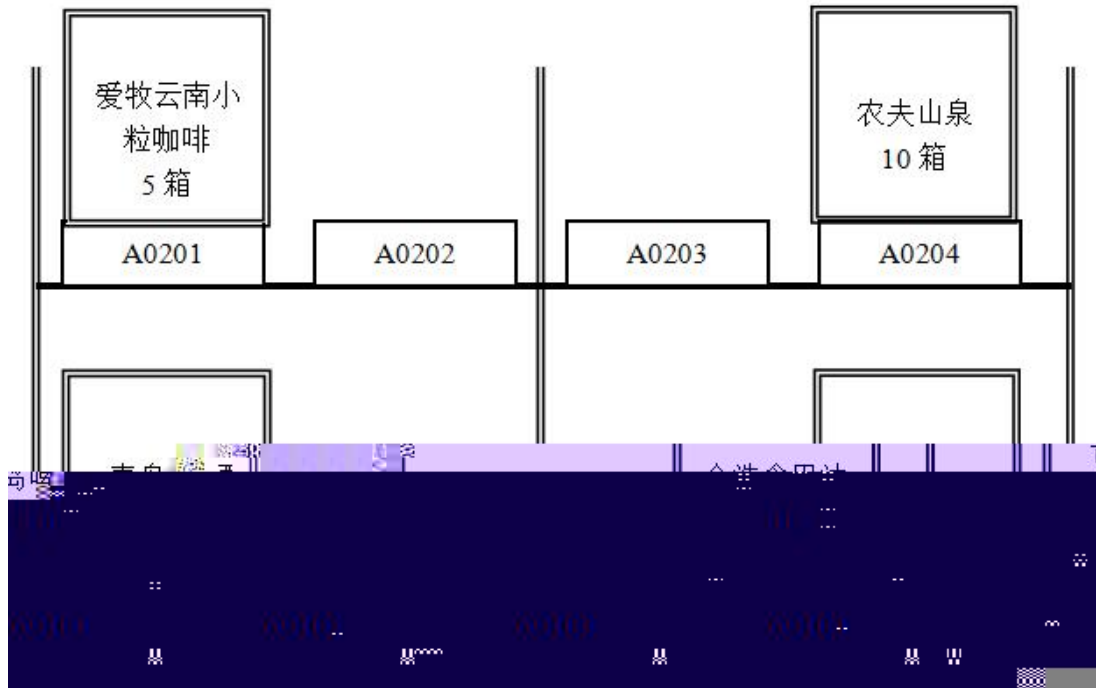

产品运输单

HD1011160001

				310ml	40		
			40		40		
3			20		20		

-
-
-
-
-
-
-
-
-

	1	

	2	1

	5			2	1
				2	
	10			1	
				2	
	10			2	
	5			2	1
				2	
80	10	ABC		6	2
			ABC	4	
	10			10	3
				1	
	5			5	
	5			3	
	5			2	
			2	3	
	5		1		
			2		
			1	3	

		2	WMS	WMS	2	
		8			6	1
					2	
		5			3	
				0.5	2	
		10			6	2
					4	
				1 0.5		30mm
		5	RF		RF	1
		7			3	1
					4	
				1 0.5		150mm
		3	RF		RF	3

2019 7 7

1 2

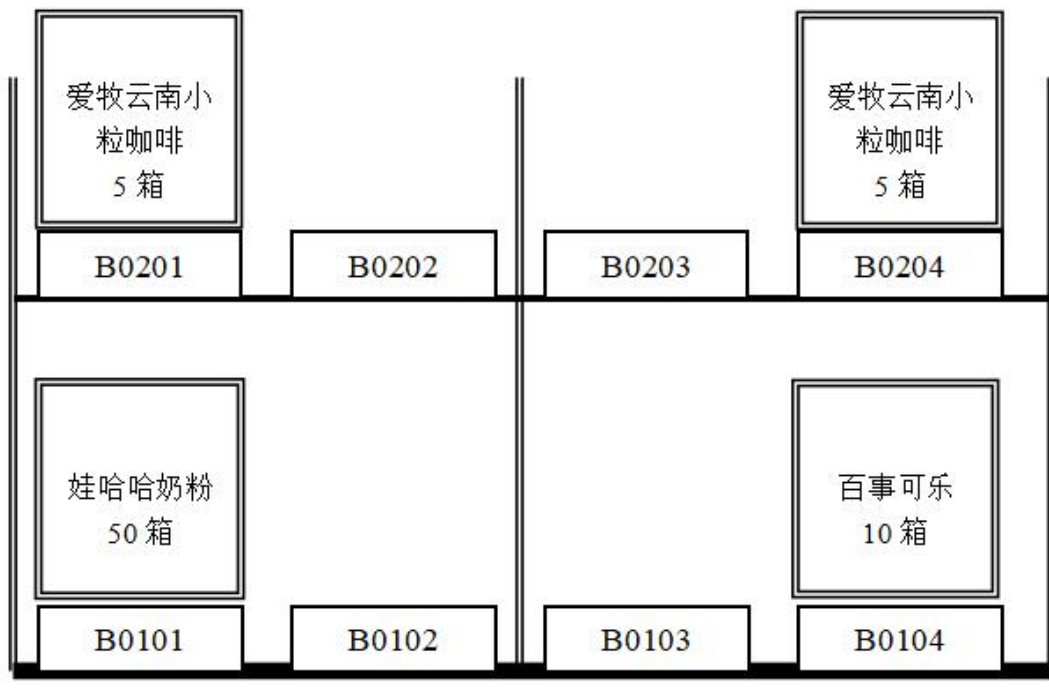
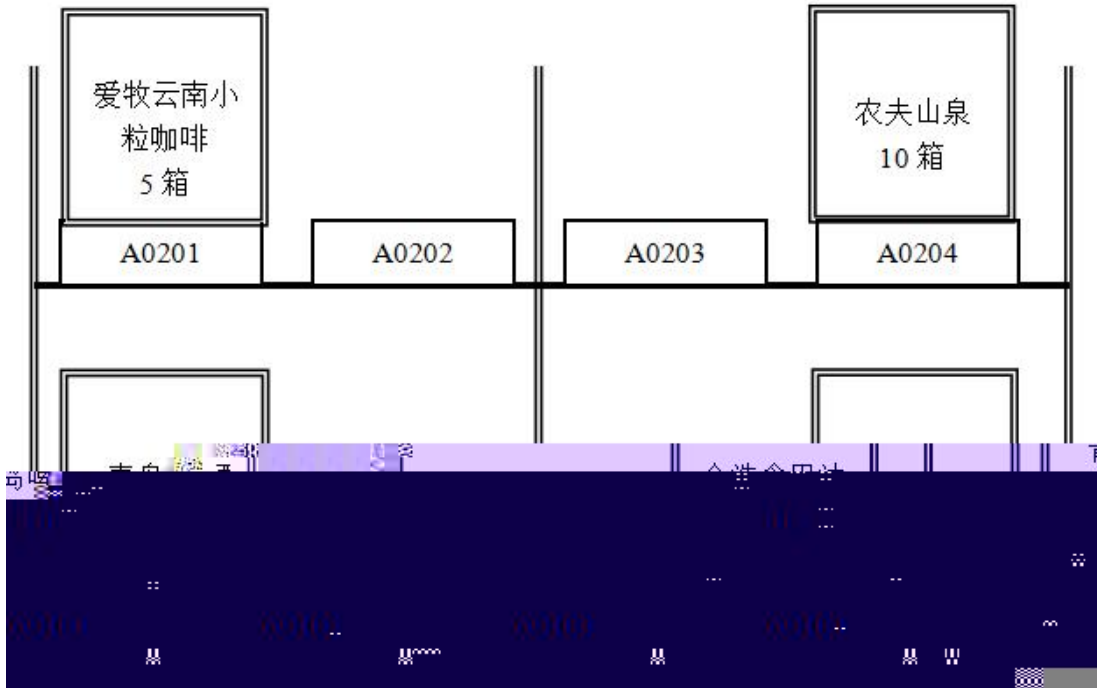

产品运输单

HD1011160001

			20	100ml*5	20		
			40	100ml	40		
			40	330ml	30		

-
-
-
-
-
-
-
-
-

	1	

	2	1

	5		2	1
	10		2	0
	5		2	1
80	10	ABC	6	2
	10		ABC	4
	10		10	3
	5		1	
	5		5	
	5		3	
5		2	3	
5		1	2	
5		2	3	

		2	WMS	WMS	2	
		8			6	1
					2	
		5			3	
				0.5	2	
		10			6	2
					4	
				1	0.5	
						30mm
		5	RF		RF	1
		7			3	1
					4	
				1	0.5	
						150mm
		3	RF		RF	3

1

2019 8 7

1 2

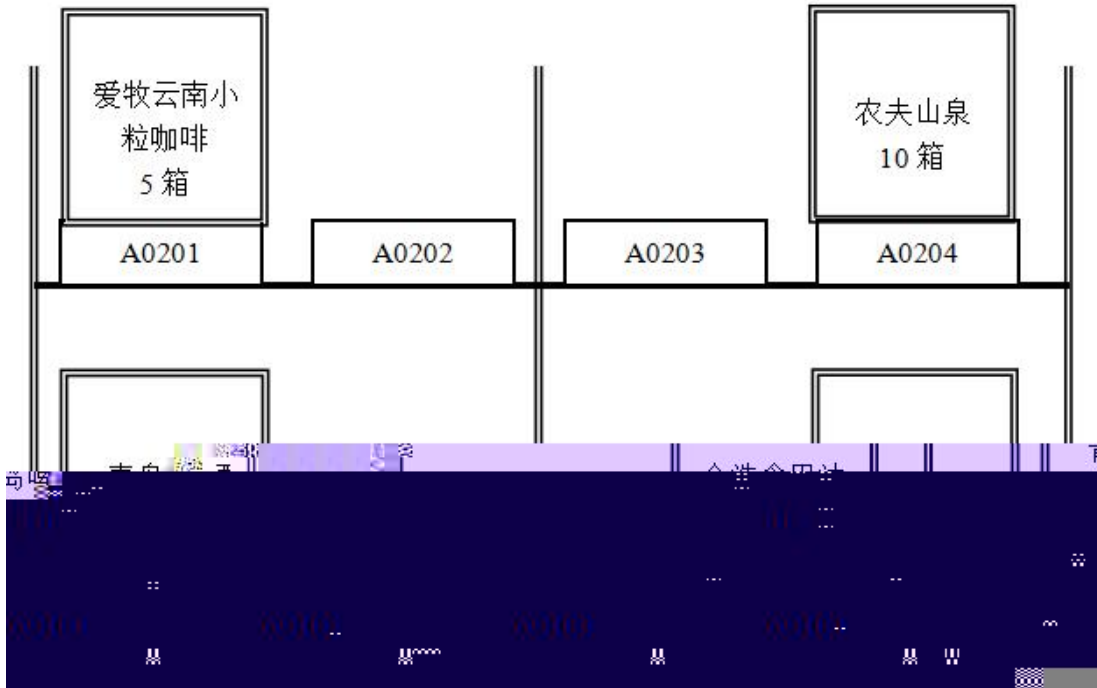

产品运输单

HD1011160001

			40	330ml	40		
			30	100ml*5	30		
			30	310ml	30		

-
-
-
-
-
-
-
-
-

	1	

	2	1

	5			2	1
				2	
	10			1	
				2	
	5			2	1
				2	
80	10	ABC		6	2
			ABC	4	
	10			10	3
				1	
	5			5	
	5			3	
	5			2	3
	5		1		
			2		
			1	3	

		2	WMS	WMS	2	
		8			6	1
					2	
		5			3	
				0.5	2	
		10			6	2
					4	
				1	0.5	
						30mm
		5	RF		RF	1
		7			3	1
					4	
				1	0.5	
						150mm
		3	RF		RF	3

2019 10 7

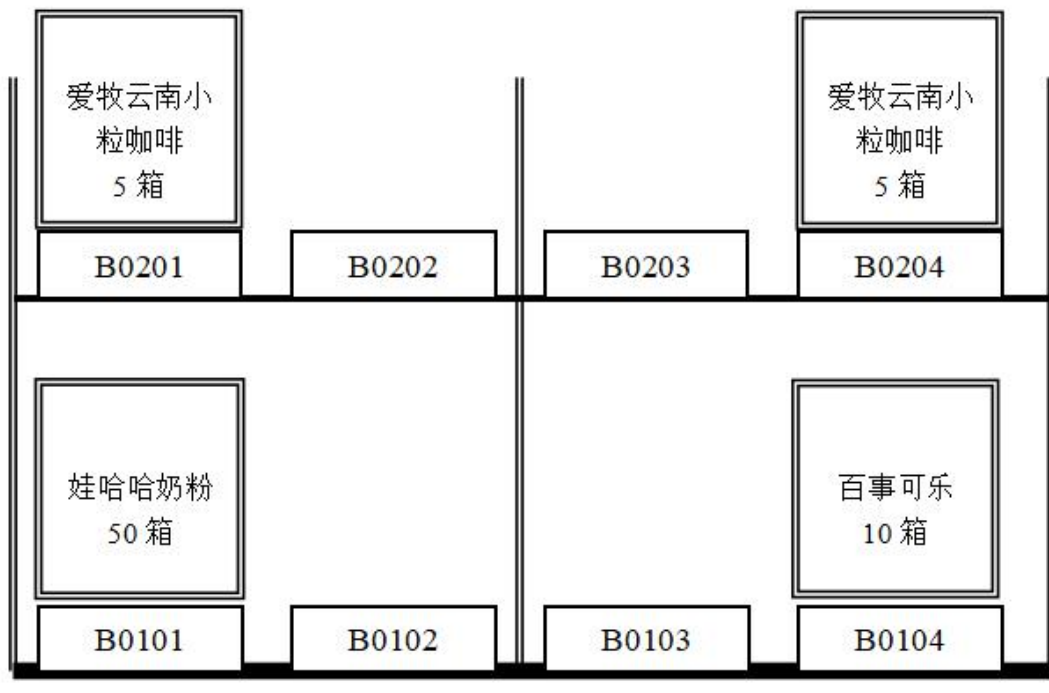
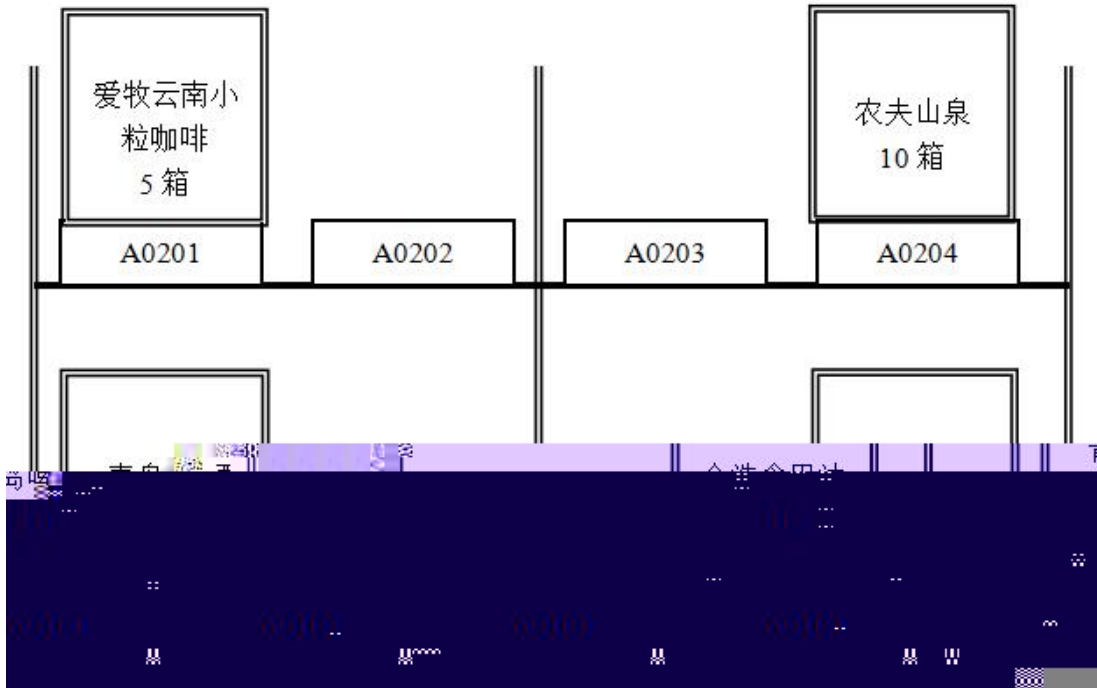

产品运输单

HD1011160001

			40	310ml	40		
			40	330ml	40		
3			20	100ml	20		

○

○

○

○

○

○

○

○

	1	

	2	1

	5			2	1
				2	
	10			1	
				2	
	5			2	1
				2	
80	10	ABC		6	2
			ABC	4	
	10			10	3
				1	
	5			5	
	5			3	
	5			2	3
5			1		
	5			2	
			1	3	

		2	WMS	WMS	2	
		8			6	1
					2	
		5			3	
				0.5	2	
		10			6	2
					4	
				1	0.5	
						30mm
		5	RF		RF	1
		7			3	1
					4	
				1	0.5	
						150mm
		3	RF		RF	3

○

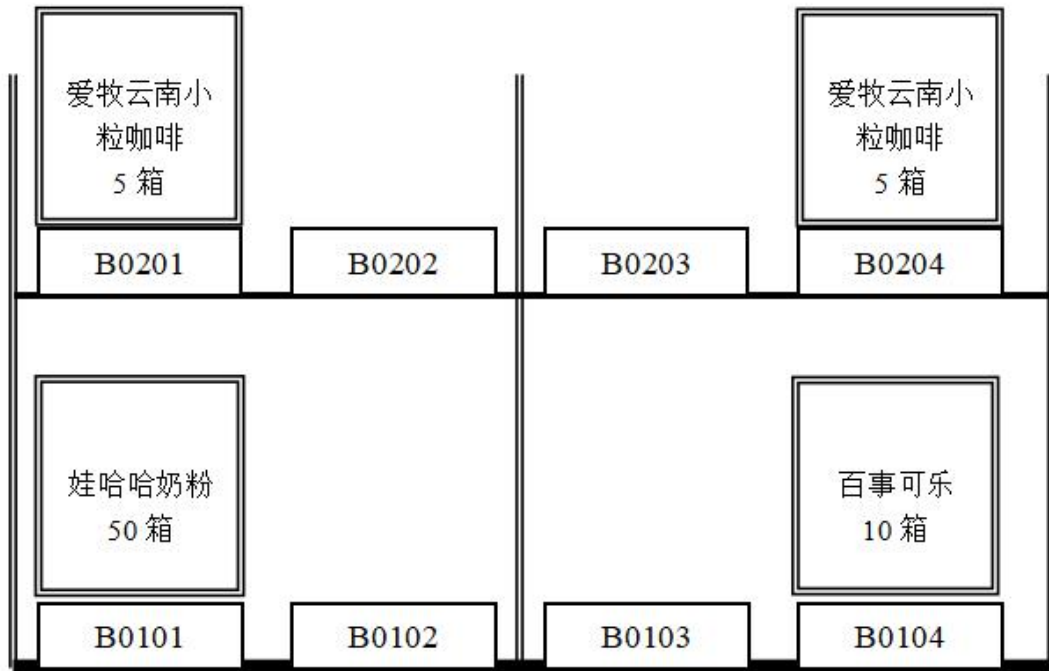
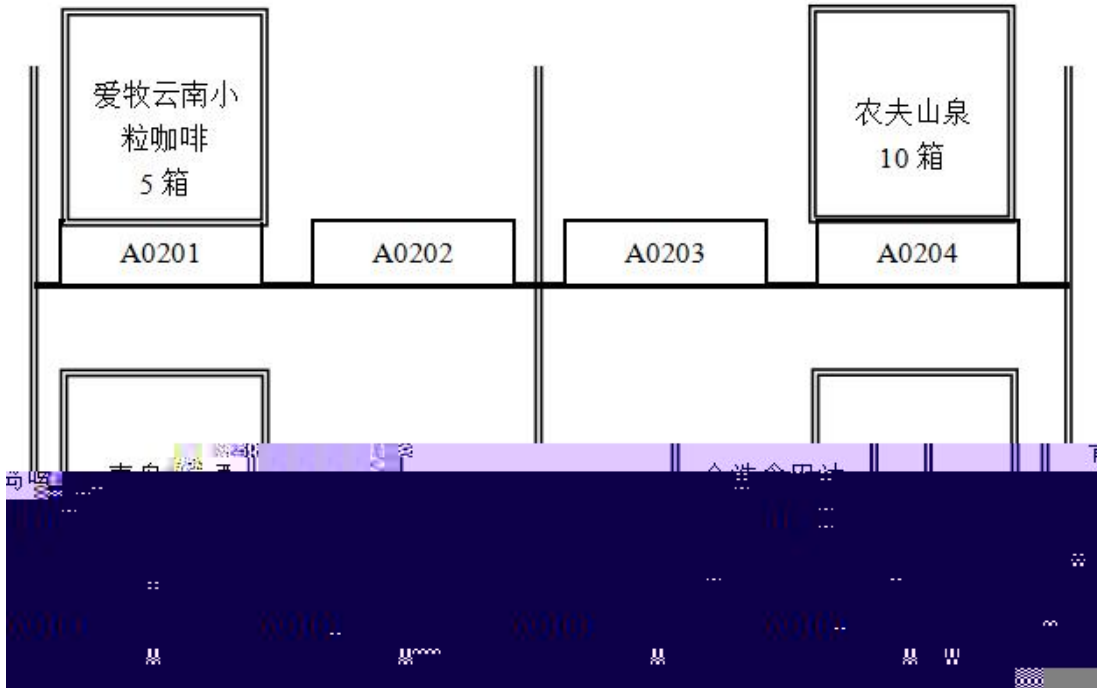



km



		10		
		10		
		20		
		10		

--	--	--	--	--	--

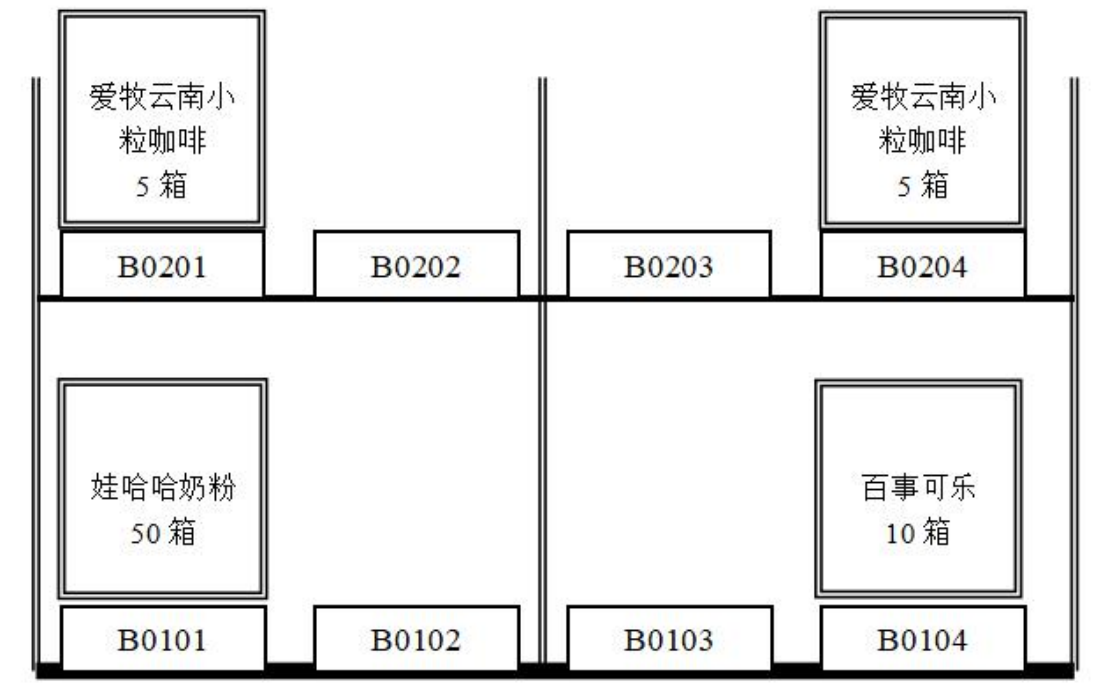
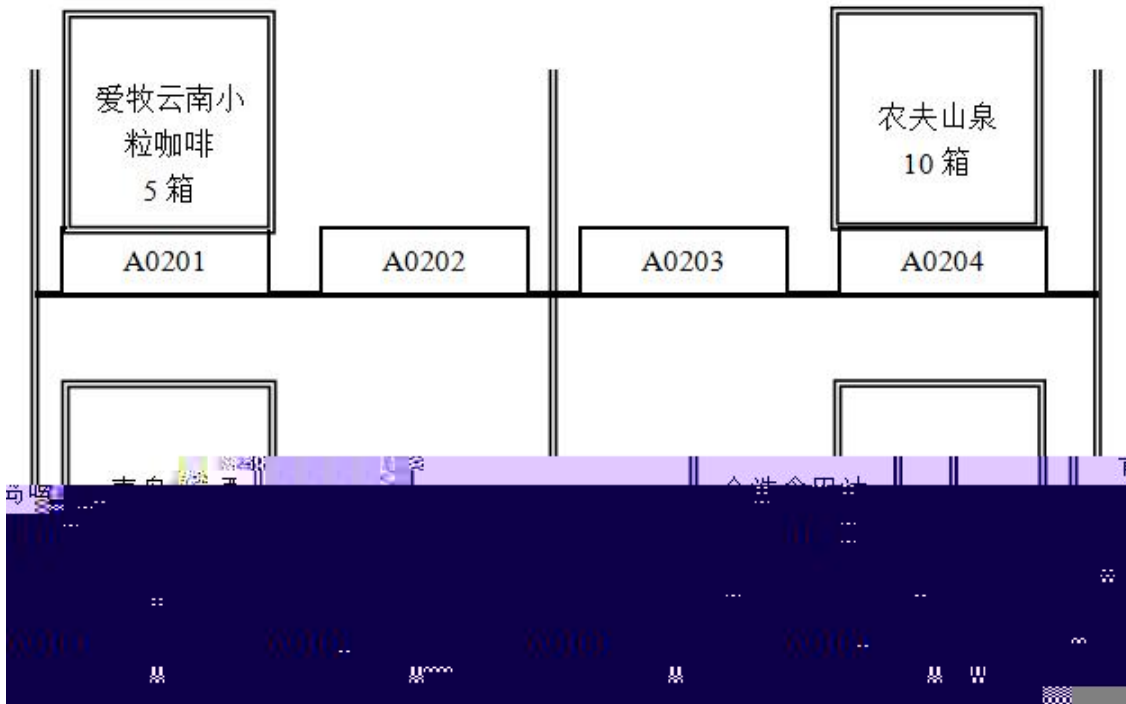

○
km

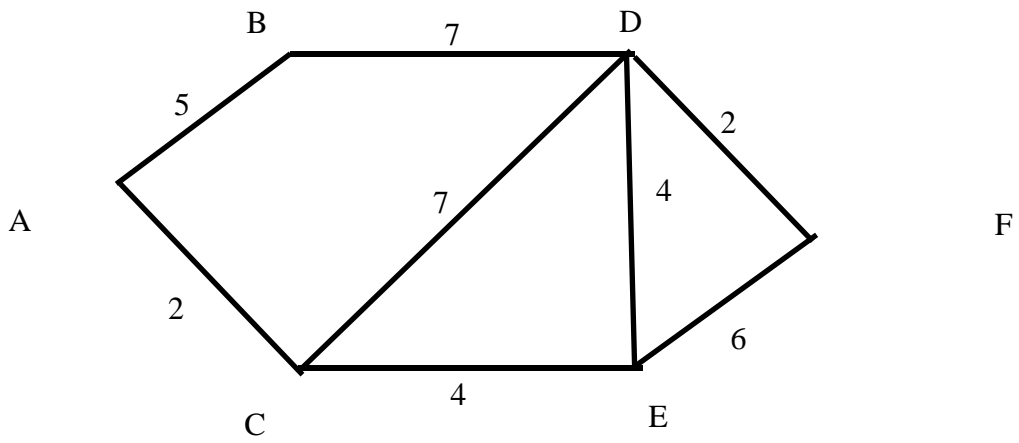

○

	5			0
	10			
	5			
	5			
	5			
	5			

15

10

10

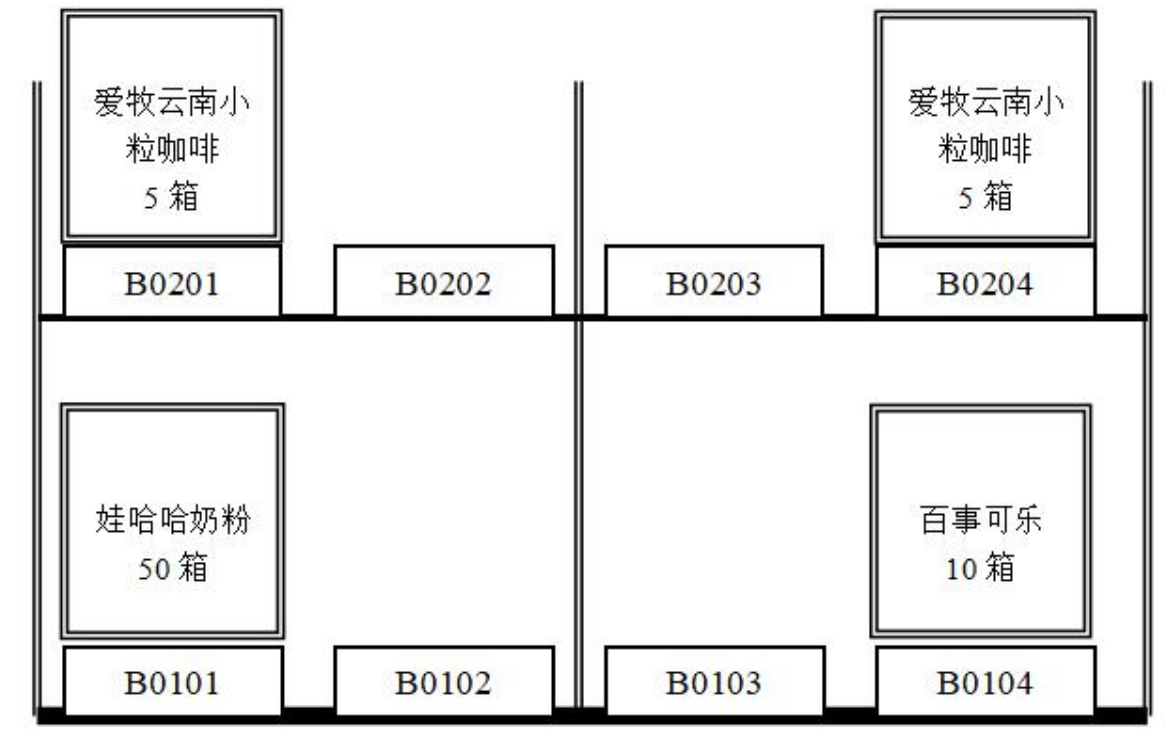
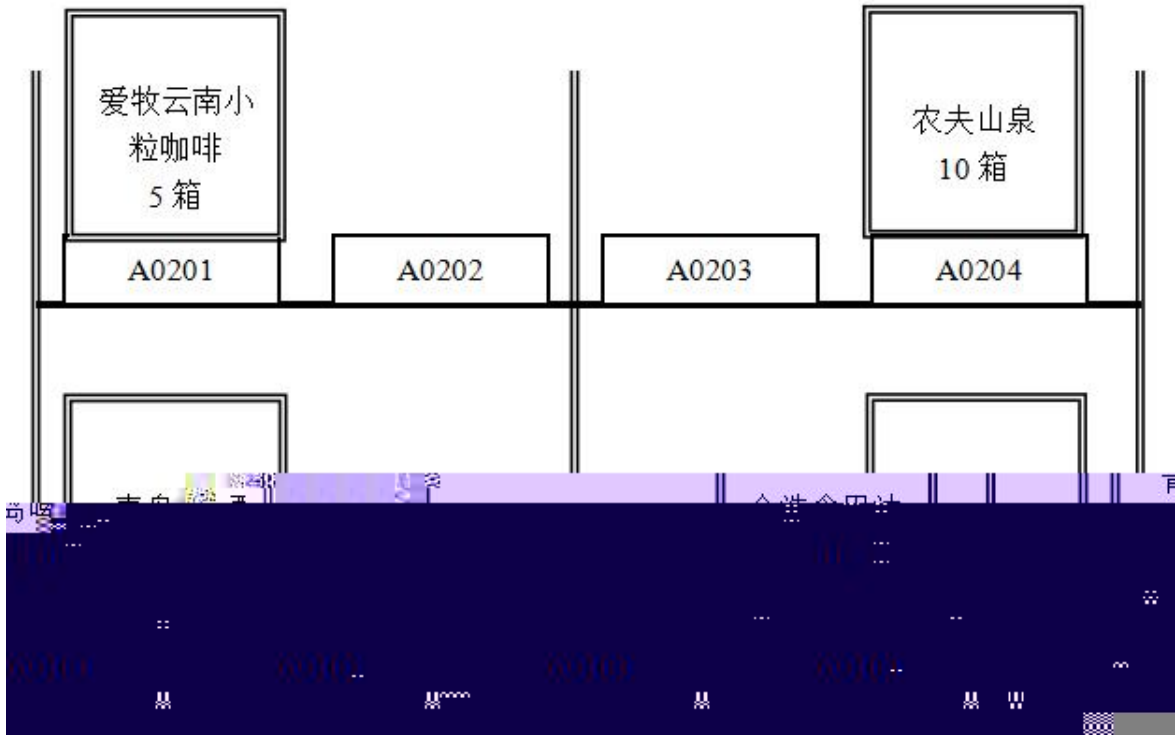

○
km

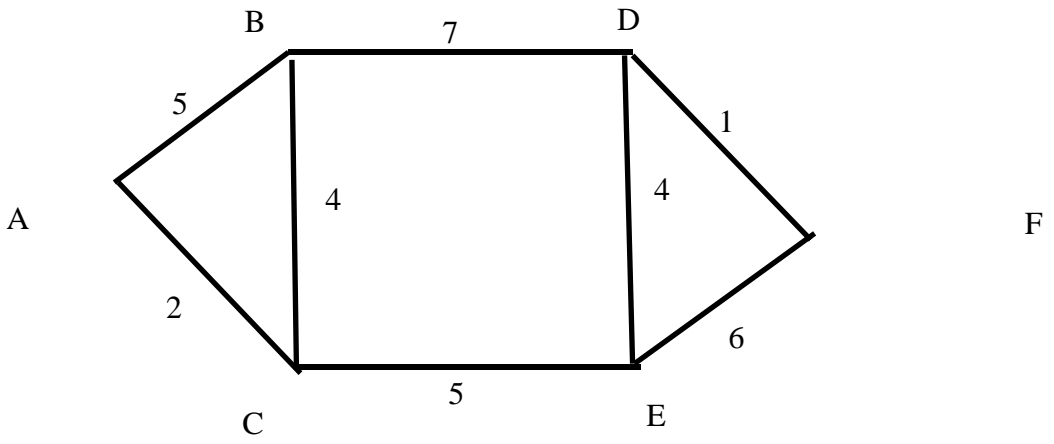

○

	5			0
	10			
	5			
		5		

		5		
		5		
		15		
		10		
		10		
		20		
		10		

1

		---	---		

		---	---		



--- ---

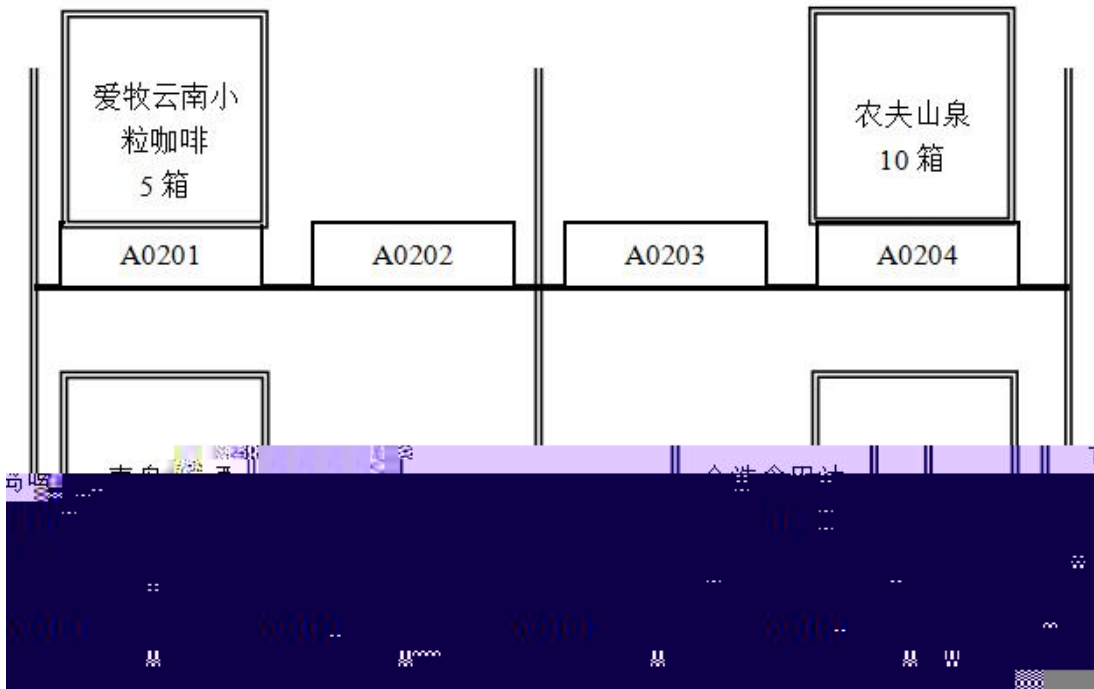

○
km

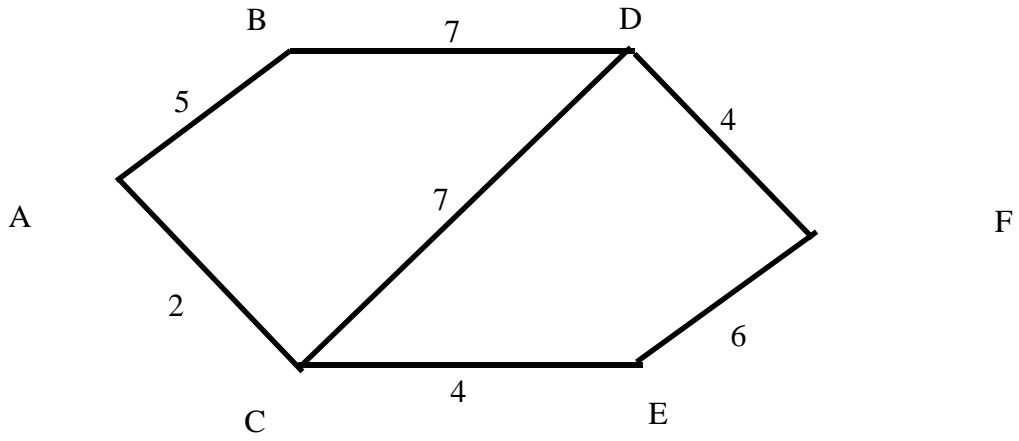

○

	5			0
	10			
	5			
	5			
	5			
	5			
	15			

		10			
		10			
		20			
		10			

1

--	--	--	--	--	--

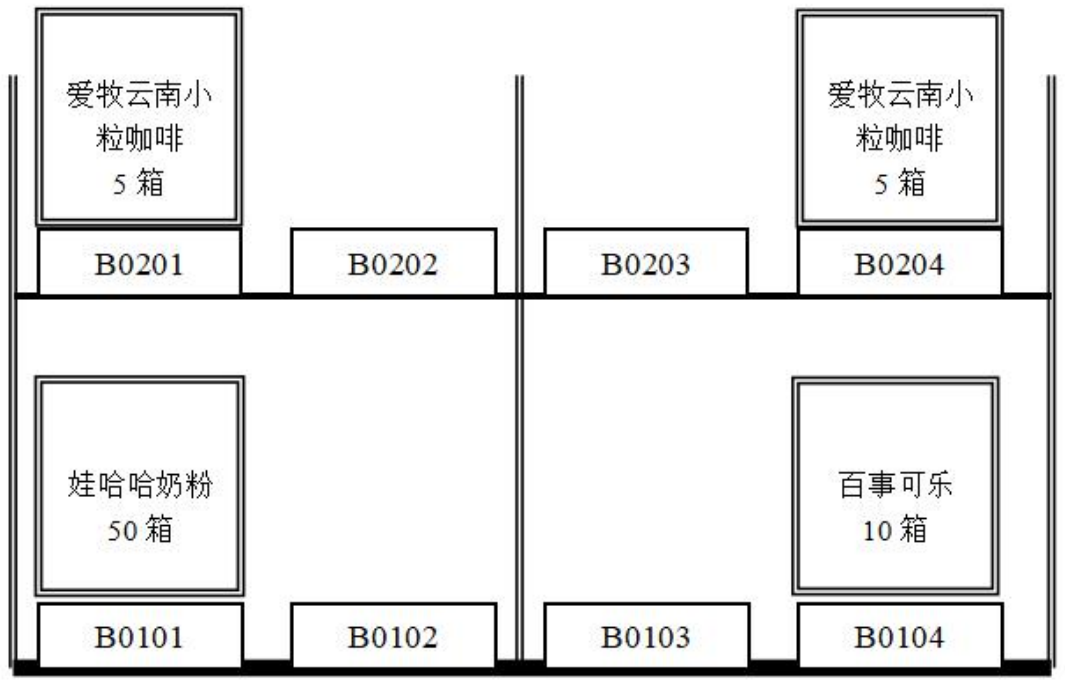
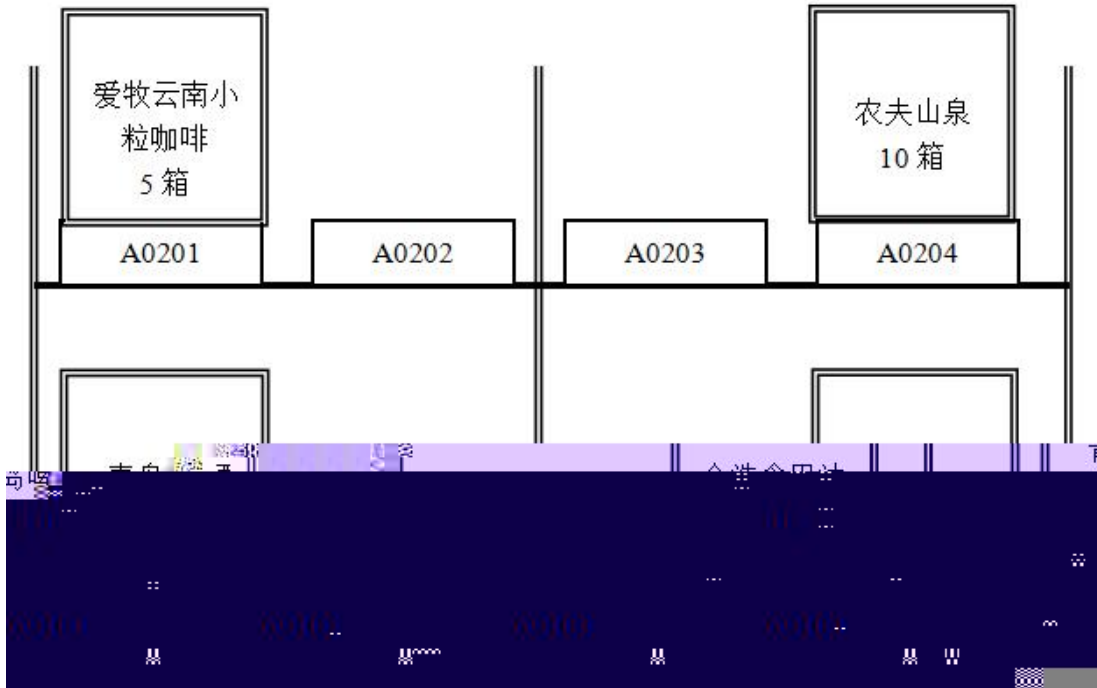



km

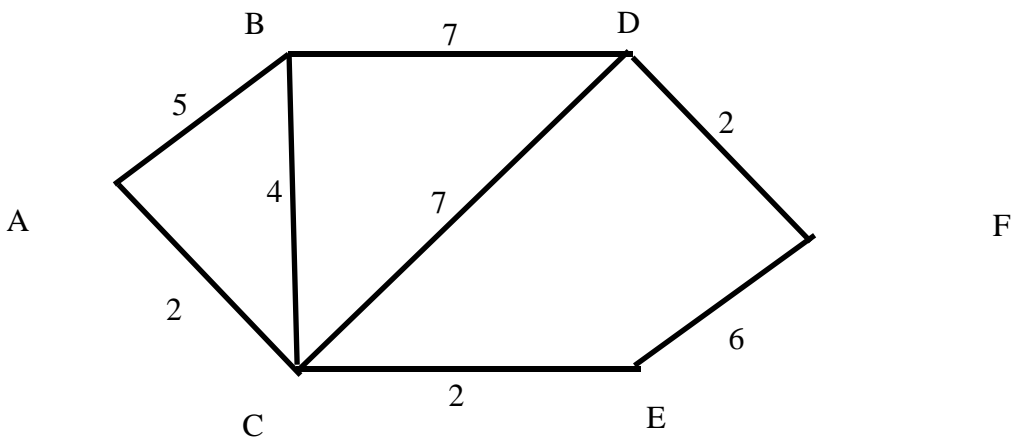

		5		
		10		
		5		0
		5		
		5		

		5			
		15			
		10			
		10			
		20			
		10			

○

○

	5		1	2 2
	10		2	1 2 1 2
	5		1	2 2
	30			0
	15			
	5			
	20			

		10			

○

○

	5		1	2 2
	10		2	1 2 1 2
	5		1	2 2
	30			0
	15			
	5			
20				

		10			

○

○

	5		1	2 2
	10		2	1 2 2 1 2
	5		1	2 2
	30			0
	15			
5				
20				

		10			

○

○

--	--

	5		1	2	
	10			1	
				2	2
5			2	2	
			1	0	
	30				
	15				
5					
20					

		10			

○

○

		10			

三、国际物流作业组织与管理模块

0

À Á Ñ

○



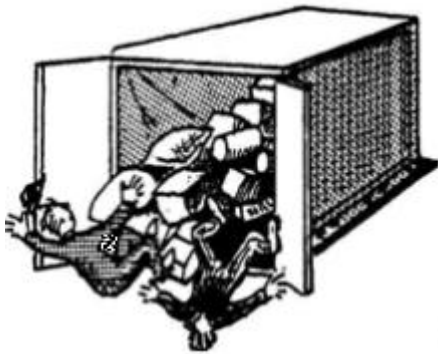
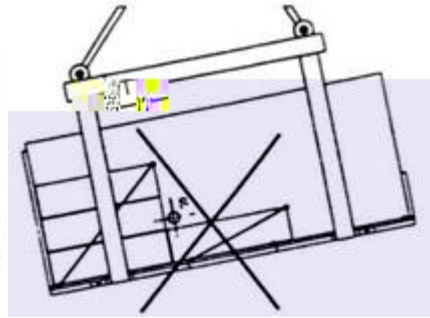

○

船公司	船名/航次	服务代码	航线	装船港/卸船港	启-达日期	天	挂港
Carrier							

○
○

BEIJING	CN		BJ\$
Y. RENMINBI	CNY		KGS
2020	111.15	8	888.95
		9	78.87
		40	44.74
		100	42.74
		200	42.29

				0

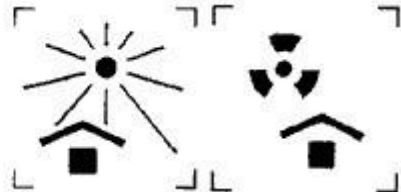

○

				0

○

○

**集装箱设备交接单
EQUIPMENT INTERCHANGE RECEIPT**

OUT 出场

用箱人/运箱人(CNTR. USER/HAULIER)		提箱地点(PLACE OF DELIVERY)	
发往地点(DELIVERED TO)		返回/收箱地点(PLACE OF RETURN)	
船名/航次(VESSEL/VOYAGE No.)	集装箱号(CNTR. No.)	尺寸/类型(SIZE/TYPER)	营运人(CNTR. OPTR)
箱号/柜号(CNTR. No.)	箱封号(SEAL No.)	免费期限(FREE TIME PERIOD)	运载工具牌号(TRUCK WAGON BARGE No.)
货重(CARGO W.)	出场目的/状态(PPS OF GATE-OUT/STATUS)	进场目的/状态(PPS OF GATE-IN/STATUS)	出场日期(TIME-OUT) 月 日 时
出场检查记录(INSPECTION AT THE TIME OF INTERCHANGE)			
普通集装箱(GP. CNTR.)	冷藏集装箱(REF. CNTR.)	特种集装箱(SEL. CNTR.)	发电机(GEN. SET)
<input type="checkbox"/> 正常(SOUND) <input type="checkbox"/> 异常(DEFFECTIVE)	<input type="checkbox"/> 正常(SOUND) <input type="checkbox"/> 异常(DEFFECTIVE)	设定温度(RECORDED) <input type="checkbox"/> 正常(SOUND) <input type="checkbox"/> 异常(DEFFECTIVE)	<input type="checkbox"/> 正常(SOUND) <input type="checkbox"/> 异常(DEFFECTIVE)
损坏记录及代号(DAMAGE CODE)			

				0

				0

--	--	--	--	--	--

				0

				0

				0

--	--	--

				0

--	--	--	--	--	--

--	--	--	--	--	--

--	--	--	--	--	--	--	--

○

				0

○



Q **U** **I** **A** **C**

				0

					0

○

--	--	--

				0

				0

				0

--	--	--	--	--	--

○

○

○

0

○

				0

				0

四、 快递物流作业组织与管理模块

--	--	--	--	--	--

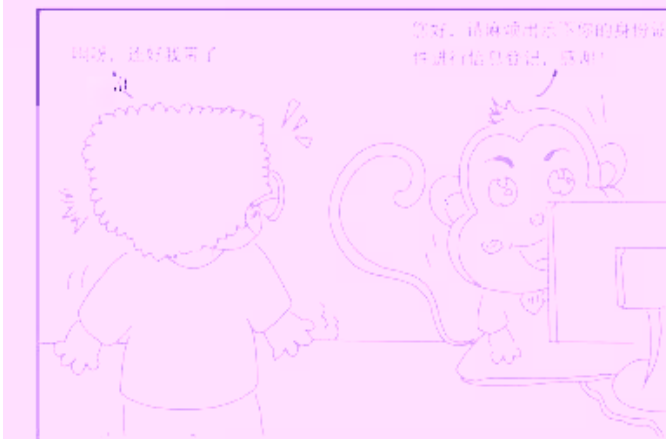
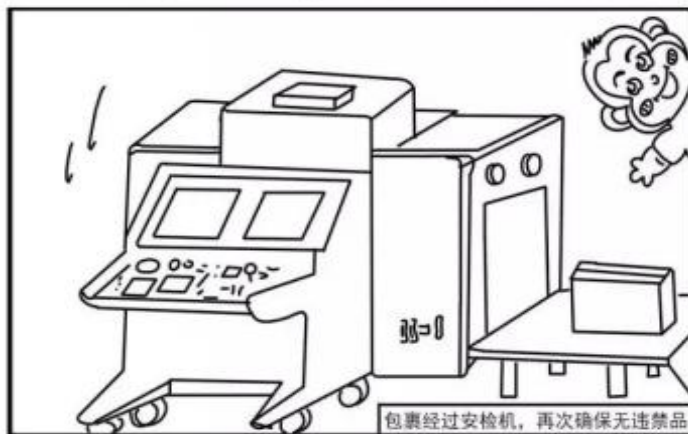
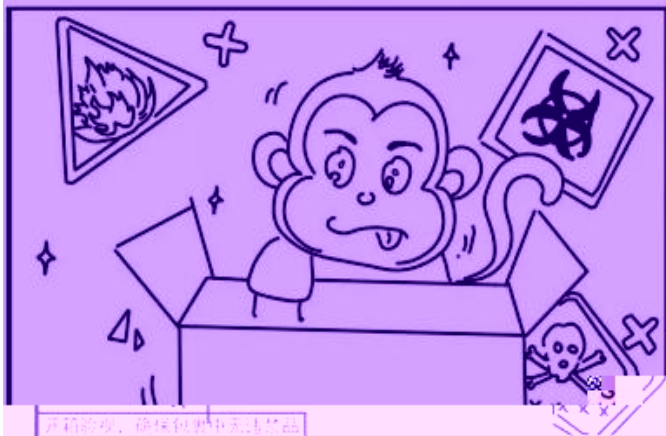

--	--	--	--	--	--

--	--	--

--	--	--	--	--	--

[想知道:中国成都理工大学校园快递具体在哪? 百度知道](#)

3个回答 - 提问时间: 2014年02月10日

最佳答案  均在银杏后面。宝盒、圆通、顺丰在电影院后面。中通、申通在图书馆下面。常用的是这几个。

zhidao.baidu.com/link?... 2014-02-15 - 百度快照 - 80%好评

--	--	--	--

--	--	--	--



--
